

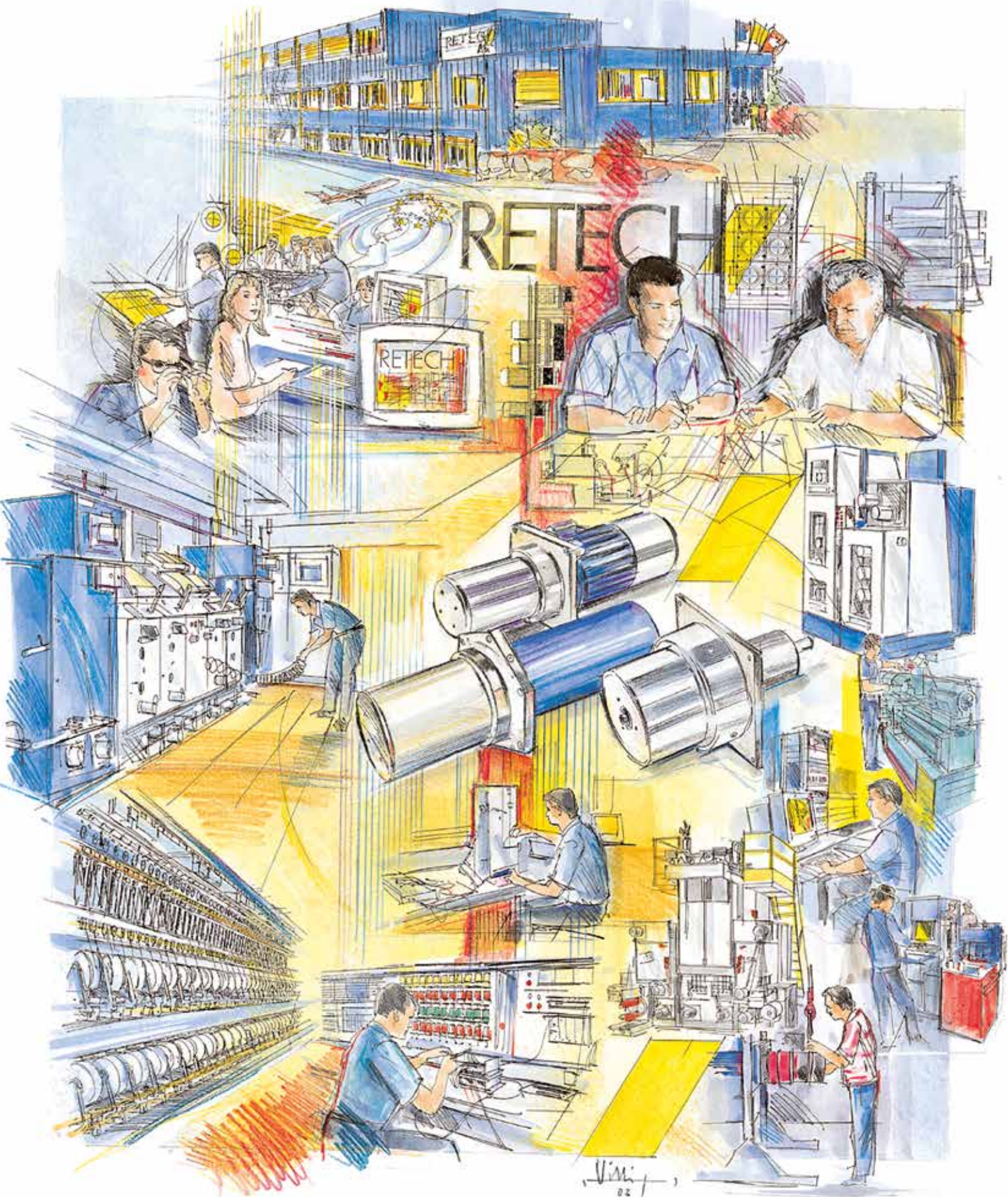

RETECH 
**expert at
drawing your
fibres to
perfection**

Heat treatment and drawing of synthetic filaments: rolls, godets, heating elements, on-line monitoring, yarn tension sensors, control systems, custom built machines.

Engineered and produced in Switzerland  Visit us at www.retech.ch



Vici
02

History and Philosophy

**Retech high quality components,
machines and on-line monitoring systems
in the production process of synthetic filaments**

Get your inspiration – become fascinated by the “blue thread”

For more than 45 years, Retech has been developing and producing components and installations for processing of synthetic filaments mainly in the field of thermal and mechanical treatment in order to create added value for our customers.

In 1974 Mr. Heinz von Arx founded the company Retech whose name stands for regulation technology and whose origin springs from temperature regulation. Learning from scratches, persistent curiosity, inspiration, progress in technology and success and failure lead to the high quality standard Retech is worldwide known for.

Retech possesses extensive know-how in design and construction of heating and drawing elements in order to provide advanced technology installations with excellent customer service. The development of innovative, efficient and high quality draw machines adapted to the customer's specification, as well as their conversion and upgrading are additional and vital topics.

At Retech the entire effort is always focused on delivering customer benefits and keeping a close contact with the clients. The mutual success is primarily based on the company knowledge and customer focus – all times and in every location with added value exclusively from Retech Switzerland.

Components

HEATING ELEMENTS

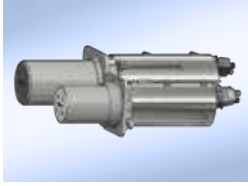

Godets / Rolls

- STS single zone induction heated rolls
- RTS multi zone induction heated rolls
- ACR ambient cooled rolls
- LCR liquid cooled rolls
- IR infrared heated rolls

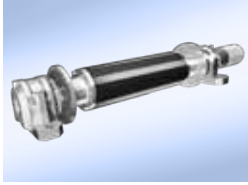

Specialities

- High temperature solutions
- High speed solutions and low speed applications
- Rolls for wash processes
- Customised adaptations/solutions

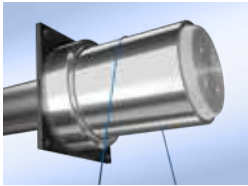

Synthetic fibre heaters

- Heated draw pins
- Heated draw rolls belt driven
- Plate heaters contact or convection
- Ovens/heaters contact or convection

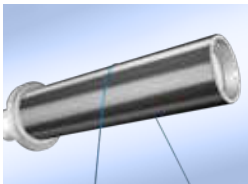

Separator rolls

- ABSR air bearing separator rolls
- Motor driven separator rolls

TEMPERATURE CONTROL

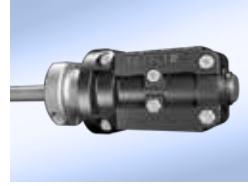

Temperature transmission system

- UTR single or multi zone transmitter



Temperature control system

- UCR-6/CR-7 single or multi zone controller
- UCR-6P multi position controller
- USC signal converter (current/voltage/frequency)
- UVI visualisation system incl. operating software



Engineering and design of:

- complete draw frames incl. all electrical devices for temperature and speed control incl. HMI and visualisation

Machines



Machines

- Vario-Max draw frame
- Custom built and pilot draw frames
- On-line drying solutions
- TEX2000 DTY pilot machine

On-Line Monitoring

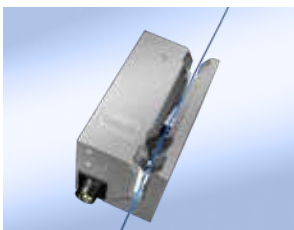

Yarn tension

- Yarn tension sensors
- Win-OLT monitoring system

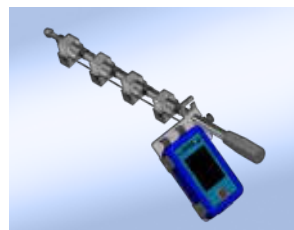

Temperature measurement

- Roll temperature surface measurement tool

Content

**Retech high quality components,
machines and on-line monitoring systems
in the production process of synthetic filaments**



Components



Heating Elements

Godet rolls – single zone induction heated – (STS or RTS)	6-7
Godet rolls – multi zone induction heated – (RTS)	8-9
Godet rolls – heated – external driven – (EDG)	10-11
Godet rolls – ambient cooled – (ACR)	12-13
Godet rolls – liquid cooled – (LCR)	14-15
Air bearing separator rolls – (ABSR)	16-17
Heated draw pins	18-19
Plate heaters – contact / convection	20-21

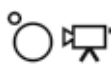

Temperature Control

Temperature transmitter for heated draw rolls – UTR-4 / UTR-4A	22
Temperature controller – UCR-6 / CR-7	23



On-line monitoring

Roll temperature surface measurement device	24-25
Yarn tension sensors	26-27
Win-OLT – on line monitoring system of yarn tension	28-31



Machines

Customized draw frames / plant engineering	32-33
TEX2000-L – DTY laboratory and pilot machine	34-35



Godet Rolls



Components in production process of synthetic filaments
Godet rolls – singlezone induction heated – (STS or RTS)



Characteristics

- Singlezone induction heated
- Stationary (STS) or rotating (RTS) temperature transmission system
- PT100 temperature sensor (thermocouple optional) with monitoring sensor (for overtemperature protection)
- Diverse surface materials available (chrome, ceramic or others)
- Diverse surface finishes available (to give optimum frictional properties)
- Thermoblocker (bearings outside the hot part of the roll)
- Non-heated versions available

Advantages

- Accurate surface temperature (for consistent yarn quality)
- High speed range
- Inexpensive
- Robust, simple modular design with installation from the front
- Low maintenance
- All electrical connections with “plug-in” facility
- No system balancing (roll exchange without rebalancing)
- No additional lubrication (lifetime bearings)
- Integrated cooling without additional cooling systems (water, oil mist, etc.)
- Low speed versions available (with gearbox, down to <5 m/min)



Components in production process of synthetic filaments Godet rolls – singlezone induction heated – (STS or RTS)

Standard Dimensions

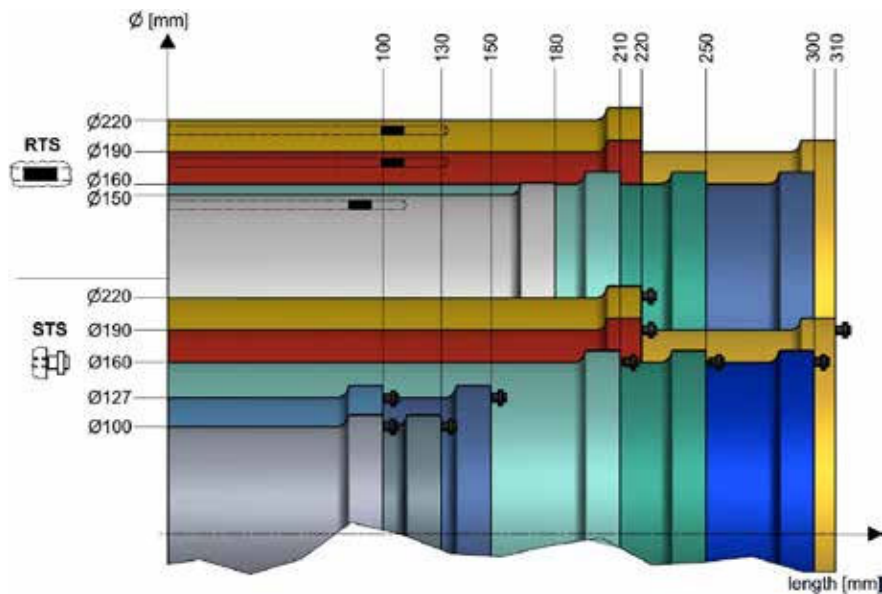

Brief Technical Specification

Yarn data	denier [max dtex]	8000 (depending on process conditions and godet size)
Process data	temperature [max °C]	60 to 250 (standard)
	speed [max m/min]	6500 (depending on roll size)
Godet data	diameter [mm]	from 100 to 220
	length [mm]	from 100 to 310
	heater type	induction
	supply voltage [V]	230 / 400
	installed power [W]	up to 10000 (depending on process conditions and godet size)
Other dimensions		available according to customer request

All rights reserved. Subject to change.



Godet Rolls



Components in production process of synthetic filaments
Godet rolls – multizone induction heated – (RTS)

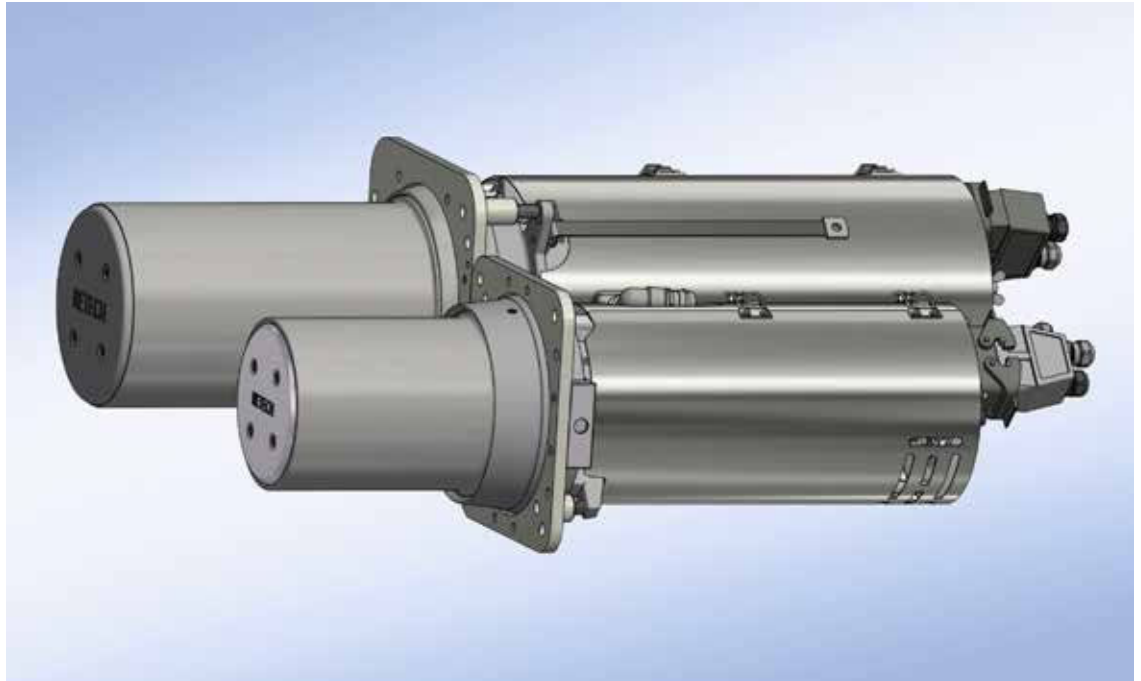

Characteristics

- Multizone (3 or 4) induction heated
- Rotating (RTS) temperature transmission system
- PT100 temperature sensors with a thermocouple to protect from overtemperature
- Diverse surface materials available (chrome, ceramic or others)
- Diverse surface finishes available (to give optimum frictional properties)
- Thermoblocker (bearings outside the hot part of the roll)
- Supplied with temperature controller for the 3 or 4 independent heating zones (CR-7)
- Specialities: induction or infra-red heated godets for high temperatures (up to 600 °C)

Advantages

- Precise temperature profile
- High speed range
- Robust, simple modular design with installation from the front
- Low maintenance
- All electrical connections with “plug-in” facility
- No system balancing (roll exchange without rebalancing)
- No additional lubrication (lifetime bearings)
- Integrated cooling without additional cooling systems (water, oil mist, etc.)
- Low speed versions available (with gearbox, down to <5 m/min)



Components in production process of synthetic filaments Godet rolls – multizone induction heated – (RTS)

Standard Dimensions

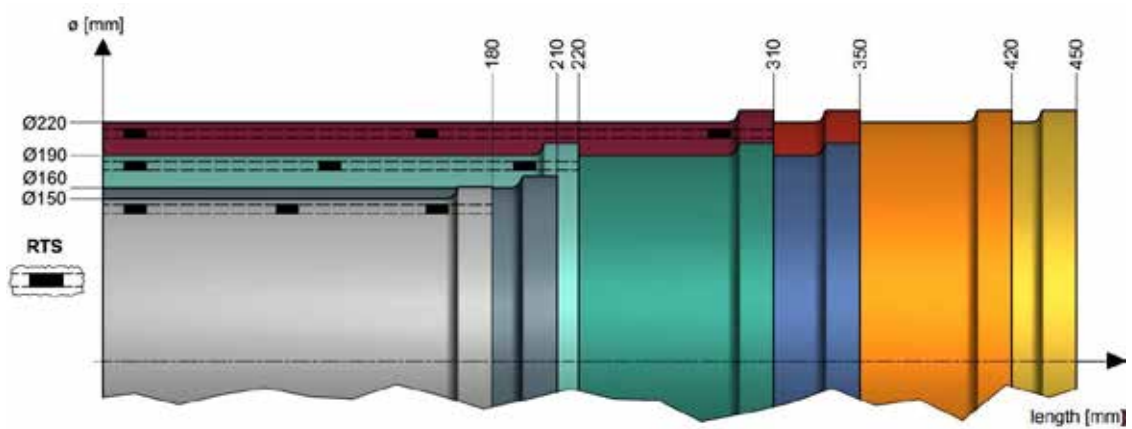

Brief Technical Specification

Yarn data	denier [max dtex]	10000 (depending on process conditions and godet size)
Process data	temperature [max °C]	60 to 250 (standard)
	speed [max m/min]	6500 (depending on roll size)
Godet data	diameter [mm]	from 150 to 220
	length [mm]	from 180 to 450
	heater type	induction
	supply voltage [V]	230 / 400
	installed power [W]	up to 24000 (depending on process conditions and godet size)
Other dimensions		available according to customer request

All rights reserved. Subject to change.



External Driven Godet Rolls



Components in production process of synthetic filaments
Godet rolls – heated – external driven – (EDG)



Characteristics

- Singlezone or multizone (3 or 4) induction or resistance heated (depending on size)
- Stationary (STS) or rotating (RTS) temperature transmission system
- PT100 temperature sensor (thermocouple optional) with monitoring sensor (for overtemperature protection)
- Diverse surface materials available (chrome, ceramic or others)
- Diverse surface finishes available (to give optimum frictional properties)
- Normally belt driven – free rotation optional

Advantages

- Accurate surface temperature (for consistent yarn quality)
- Inexpensive
- Robust, simple modular design with installation from the front
- Low maintenance bearings for highest temperatures
- All electrical connections with “plug-in” facility
- No system balancing (roll exchange without rebalancing)
- No additional lubrication (lifetime bearings)
- Integrated cooling without additional cooling systems (water, oil mist, etc.)
- Low speed versions available (with gearbox, down to <5 m/min)



Components in production process of synthetic filaments Godet rolls – heated – external driven – (EDG)

Standard Dimensions

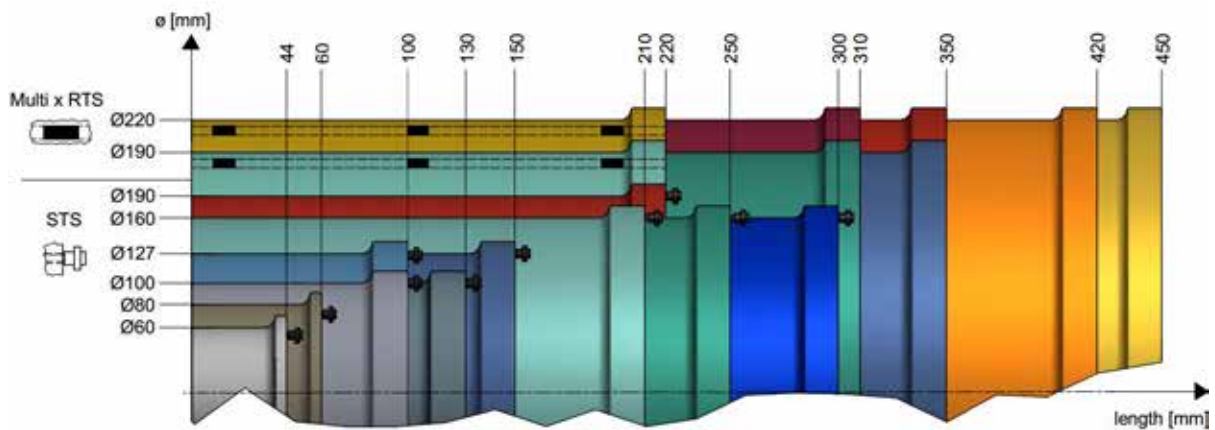

Brief Technical Specification

Yarn data	denier [max dtex]	8000 (depending on process conditions and godet size)
Process data	temperature [max °C]	resistance: 60 to 220 induction: 60 to 250
	speed [max m/min]	up to 3000 (depending on roll size)
Draw roll data	diameter [mm]	resistance: from 60 to 80 induction singlezone (STS): from 100 to 190 induction multizone (RTS): from 190 to 220
	length [mm]	resistance: from 44 to 60 induction singlezone (STS): from 100 to 300 induction multizone (RTS): from 220 to 450
	supply voltage [V]	230 / 400
	frequency [Hz]	50 / 60
	installed power [W]	300 to 10000 (depending on process conditions and godet size)
	Other dimensions	

All rights reserved. Subject to change.



Cooled Godet Rolls



Components in production process of synthetic filaments
Ambient cooled rolls – (ACR)



Characteristics

- Ambient tempered roll surface
- Diverse surface materials available (chrome, ceramic or others)
- Diverse surface finishes available (to give optimum frictional properties)

Advantages

- High speed range
- Inexpensive
- Robust, simple modular design with installation from the front
- Low maintenance
- All electrical connections with “plug-in” facility
- No system balancing (roll exchange without rebalancing)
- No additional lubrication (lifetime bearings)
- Integrated cooling without additional cooling systems (water, oil mist, etc.)
- Low speed versions available (with gearbox, down to <math><5\text{ m/min}</math>)



Components in production process of synthetic filaments Ambient cooled rolls – (ACR)

Standard Dimensions

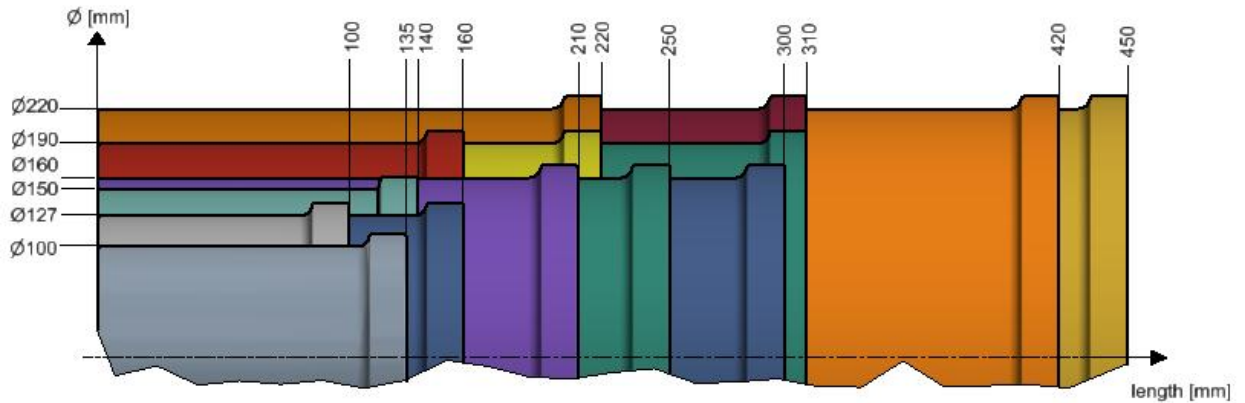

Brief Technical Specification

Yarn data	denier [max dtex]	8000 (depending on process conditions and godet size)
Process data	temperature [max °C]	ambient (max. 100 °C)
	speed [max m/min]	6500 (depending on roll size)
Godet data	diameter [mm]	from 100 to 220
	length [mm]	from 100 to 450
Other dimensions		available according to customer request

All rights reserved. Subject to change.



Cooled Godet Rolls



Components in production process of synthetic filaments
Liquid cooled rolls – (LCR)



Characteristics

- Singlezone forced cooling (chilled water)
- Rotating (RTS) temperature transmission system
- PT100 temperature sensor
- Diverse surface materials available (chrome, ceramic or others)
- Diverse surface finishes available (to give optimum frictional properties)
- Maintenance free seal system
- Supplied with or without temperature controller

Advantages

- Precise cooling
- Accurate surface temperature (for consistent yarn quality)
- Low and high speed range
- Robust, simple modular design with installation from the front
- Low maintenance
- All electrical connections with “plug-in” facility
- No system balancing (roll exchange without rebalancing)
- No additional lubrication (lifetime bearings)
- Low speed versions available (with gearbox, down to <5 m/min)



Components in production process of synthetic filaments Liquid cooled rolls – (LCR)

Standard Dimensions

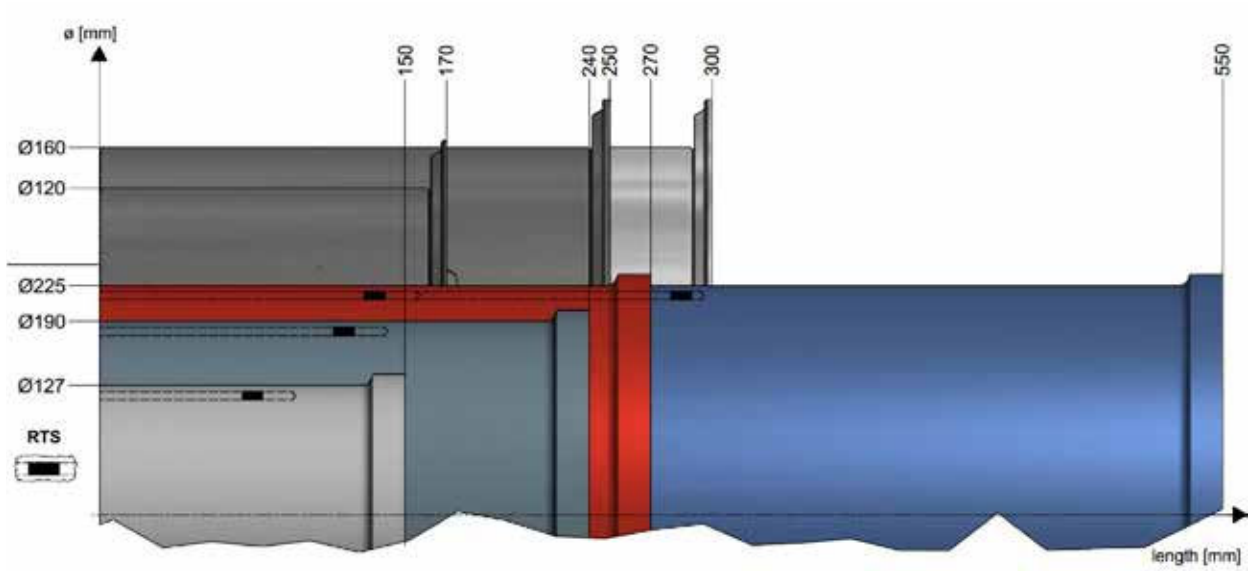

Brief Technical Specification

Yarn data	denier [max dtex]	8000 (depending on process conditions and godet size)
Process data	temperature [max °C]	cooled: 20 to 70
	speed [max m/min]	up to 4500 (depending on roll size)
Godet data	diameter [mm]	from 127 to 225
	length [mm]	from 150 to 550
	cooling type	liquid
	cooling power [W]	50 to 4000
Other dimensions		available according to customer request

All rights reserved. Subject to change.



Separator Rolls



Components in production process of synthetic filaments
Air bearing separator rolls (ABSR)



Characteristics

- Application for a large range of temperatures, max. process temperature 250 °C
- High speed applications, up to 5.500 m / min.
- Low breakaway torque (micro filament applications)
- High radial forces for high tenacity applications
- Various surface materials available
- Various surface finishes available
- Resistant against chemical environment and pollution

Advantages

- Up to 30% less air consumption versus conventional air driven separator rolls
- Large application/process range: e.g.: FDY, BCF, PET, PA, PP, technical yarn, ultra high tenacity yarn
- Low wear and tear
- Low maintenance
- No additional lubrication
- Easy fitting into existing flange and perfect combination with godet roll



Components in production process of synthetic filaments Air bearing separator rolls (ABSR)

Standard Dimensions

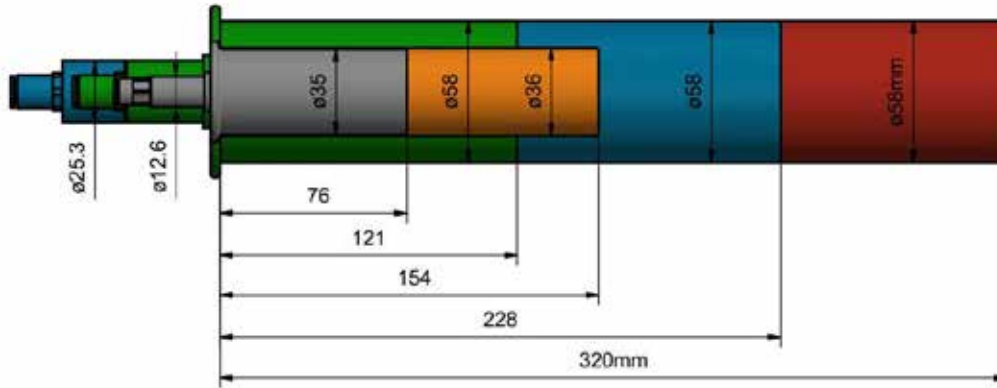

Schematic Function

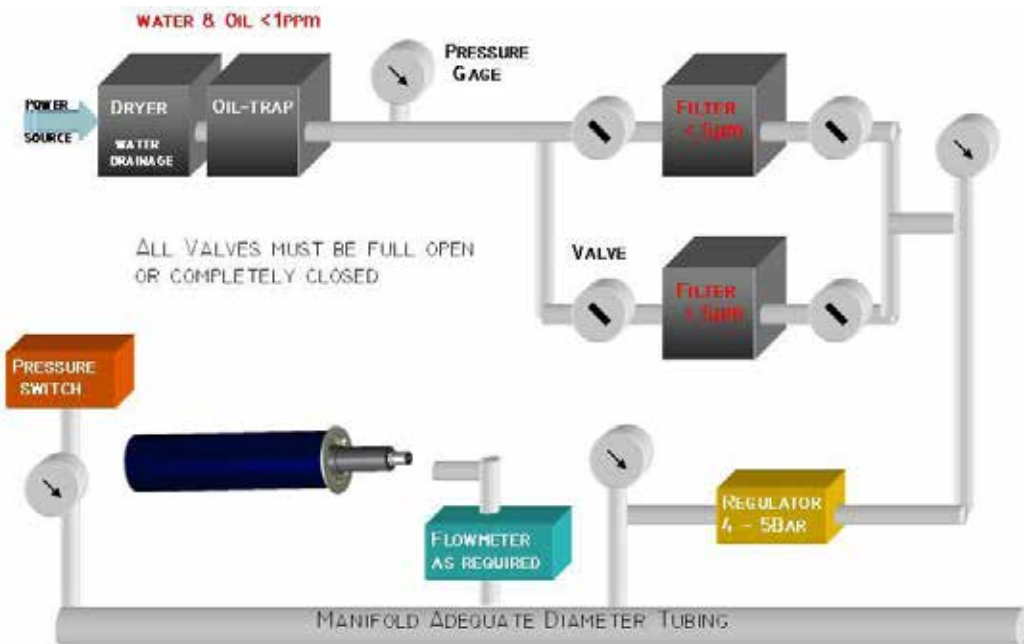

Brief Technical Specification

Yarn data	denier [max dtex]	10000 (depending on process conditions and roll size)
Process data	speed [max m/min]	up to 6000 (depending on roll size)
Technical data	diameter [mm]	from 35 to 58
	length [mm]	from 80 to 320
	radial forces [N]	up to 400 (depending on roll size)
	air pressure [Bar]	from 3 to 4,5 (depending on roll size)
	air quantity [NL/min]	from 35 to 60 (depending on roll size)

All rights reserved. Subject to change.



Draw Pins



Components in production process of synthetic filaments
Heated draw pins



Characteristics

- PT100 sensor (thermocouple optional) with monitoring sensor (for overtemperature protection)
- Diverse surface materials available (chrome or ceramic)
- Diverse surface finishes available (smooth, or knurled or orange peel) to give optimum frictional properties

Advantages

- Accurate surface temperature (for consistent yarn quality)
- Range of sizes available
- Extended life of surface
- Diverse surface materials and finishes for yarn treatment without damage
- Exchangeable sleeves with recoverable surface



Components in production process of synthetic filaments Heated draw pins

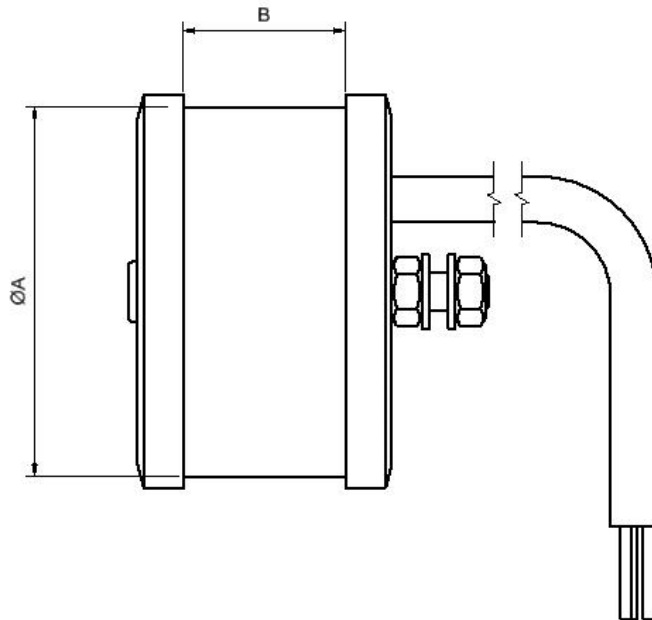

Standard Dimensions

ØA mm	B mm	Supply Volt	Output Watt
40	30	115/230	70
60	35	115/230	200
80	35	115/230	300

Brief Technical Specification

Yarn data	denier [max dtex]	600 (depending on process conditions)
Process data	temperature [max °C]	60 to 250
	speed [max m/min]	1000 (depending on process conditions)
Heater data	heater type	resistance
	diameter [mm]	from 40 to 80
	supply voltage [V]	115 / 230
	frequency [Hz]	50 / 60
	installed power [W]	70 to 300

All rights reserved. Subject to change.



Plate Heaters



Components in production process of synthetic filaments
Plate heaters – contact / convection



Characteristics

- Contact principle or convection principle
- Resistance heated
- PT100 sensors or thermocouple with optional monitoring sensor for overtemperature protection
- Alternative surface material (chrome or ceramic)
- Diverse surface finishes
- Specialities: double sided hot plates

Advantages

- Accurate surface temperature
- Alternative lengths
- Extended surface life
- Recoverable surface
- Diverse surface finishes for yarn treatment without damage



Components in production process of synthetic filaments Plate heaters – contact / convection

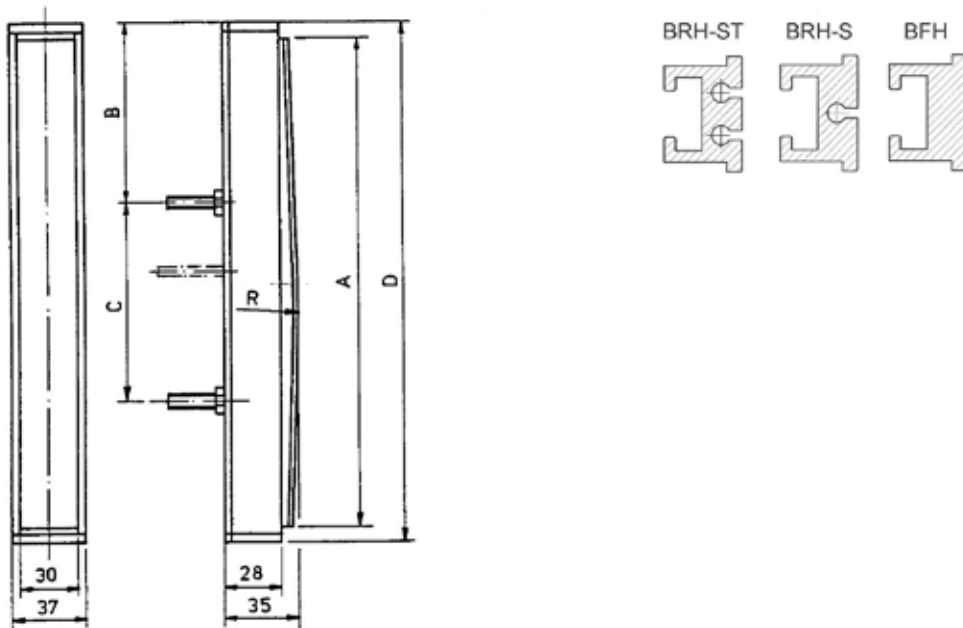

Standard Dimensions

Size Inch	A mm	B mm	C mm	D mm	Rating Watt
6	150	23	86	173	125
8	200	60	102	223	200
10	250	85	102	273	200
12	300	82	160	323	240
16	400	71	280	423	340
20	500	111	300	523	400

Brief Technical Specification

Yarn data	denier [max dtex]	2000 (depending on process conditions)
Process data	temperature [max °C]	60 to 250
	speed [max m/min]	2000 (depending on process conditions)
Heater data	heater type	resistance
	length [mm]	150 - 500
	supply voltage [V]	115 / 230
	frequency [Hz]	50 / 60
	installed power [W]	125 to 400

All rights reserved. Subject to change.



Temperature Transmitters



Components in production process of synthetic filaments
Temperature transmitter for heated draw rolls – UTR-4 / UTR-4A



Characteristics

- 1 temperature transmitter for 1 to 6 individual heating zones (up to 6 x PT100 inputs)
- Plug-in PT100
- Completely sealed, no connections in the hot part of the roll
- Information on status for system analysis, sensor equipped for environment condition check
- PT100 error monitoring with detailed information
- Used in combination with CR-7 (single/multizone) controller or USC signal converter

Advantages

- Few components, easy maintenance
- Fast fitting using screws and plug
- No wiring on the spot, no stripping nor screwing of contacts
- Can be supplied for up to 6 independent measuring zones
- Data transfer in digital form. Accuracy of measurement unaffected by cable length
- Hot plug technology (no power off needed at exchange)
- Low power consumption
- Robust design
- Additional safety by environment checking sensor

Applications

- Direct connection to Retech temperature controller CR-7 or USC signal converter (4 – 20 mA, 0 – 10 V, frequency, etc.)
- PLC read-out for user specific controls
- Supervision of high-temperature rolls up to 500 °C



Temperature Controllers

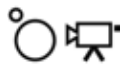

Components in production process of synthetic filaments
UCR-6 / CR-7 (single/multizone/multichannel) controller



Characteristics

- 6 individual heating positions on 1 board (6 x PT100 inputs, 6 x power / SSR outputs)
- Direct access to PT100
- 1 controller for up to 6 individual heating zones
- 1 to 6 x PT100 inputs, 1 to 6 x power / SSR outputs
- Diverse integrated bus systems (Profibus, RS-485, CAN)
- Heating-overtemperature monitoring
- DIN rail mounted
- Used in combination with UTR temperature transmission system

Advantages

- Located close to the machine or inside a control cabinet
- All cables fitted with plugs (easy connection and maintenance)
- 1 to 6 x or 6 x individual control loops with independent heating parameters giving an excellent temperature profile (temperature control accuracy +/- 0.5 °C)
- Can be integrated to existing machine control using diverse bus systems or can be supplied as independent system via Retech software and panel
- Softstart for power (low mains load)
- Low power consumption

Applications

- Control of godets with temperature transmitter
- Control of heaters with PT100



Roll Temperature Measurement

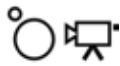

Components in production process of synthetic filaments
Roll temperature surface measurement device



Characteristics

- Temperature measurement tool for godets with up to 4 individual measuring points
- Battery powered for independent working
- USB powered for long term registrations

Advantages

- Measurement of all zones in mechanically defined distances; every godet equally measured
- Contacting of roll with always same contacting angle and pressure; independent of operator
- Saving of maximum temperature of each godet with identification-number, time and date
- No need of heat transfer compound
- Calibration of temperature sensors to a reference
- Backlight display for measurement in dark environment
- Splash water protected for harsh environment

Functions

- Measurement of actual / maximum temperature with registration option
- Long term registrations
- Transfer of data to a computer

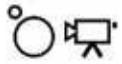

Components in production process of synthetic filaments Roll temperature surface measurement device

Technical Description Temperature Reading Device



Operating Menus

Initialisation menu

- User specific parameters

Temperature offset correction

- Possibility to reference the thermocouples

Working menu

- Continuous temperature measurement
- Peak temperature measurement
- Registration with associated godet identification on Micro SD-card

General information

- Device activation with push-button
- Last used menu will be set as starting menu at next power-ON
- Temperature indication in °C with a resolution of 0.1 °C

Working Principle

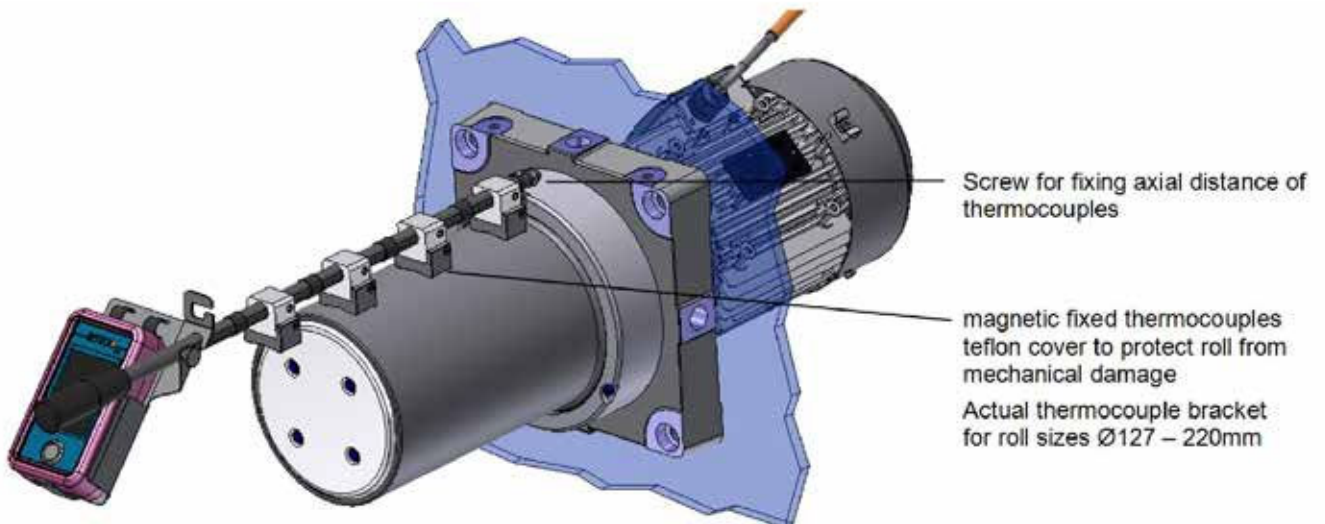

Laufnummer	Maschinen-Nr	Position-Nr	Galeiten-Nr	Soll-Temp	Temp 1	Temp 2	Temp 3	Temp 4	Zeit	Trim 1	Trim 2	Trim 3	Trim 4
1	21	1	1	220	219.3	220.0	219.6	219.9	2015-06-11-11:20	-0.7	0.0	-0.2	-0.1
2	21	1	2	220	219.3	220.0	219.6	219.9	2015-06-11-11:21	-0.7	0.0	-0.2	-0.1
3	21	1	3	220	219.3	220.0	219.8	219.9	2015-06-11-11:22	-0.7	0.0	-0.2	-0.1
4	21	1	4	220	219.3	220.0	219.8	219.9	2015-06-11-11:23	-0.7	0.0	-0.2	-0.1
5	21	1	5	220	219.3	220.0	219.8	219.9	2015-06-11-11:24	-0.7	0.0	-0.2	-0.1
6	21	1	6	220	219.3	220.0	219.8	219.9	2015-06-11-11:25	-0.7	0.0	-0.2	-0.1
7	21	1	7	220	219.3	220.0	219.8	219.9	2015-06-11-11:26	-0.7	0.0	-0.2	-0.1
8	21	1	8	220	219.3	220.0	219.8	219.9	2015-06-11-11:27	-0.7	0.0	-0.2	-0.1

Outputfile of measurement on Micro SD-card



Yarn Tension Sensors

Components in production process of synthetic filaments Yarn tension sensors



The monitoring of the yarn tension of textile machines is used as quality characteristic. With the aid of the measurement and the following control system of the yarn tension, better results could be achieved at the processing of the yarn. Also quality degradations such as thin places and knurls could be avoided.

Previous methods and technology for the measurement of the yarn tension are strongly affected by influences of the environment. Mechanical systems are afflicted with wear. The characteristics of the yarn tension sensor are improved by the use of innovative Hall technology. In practice they offer an advantage of non wastage and an optimum of long-term precision.

This yarn tension sensor is able to be used for highly reliable and exact supervision in the texturing and other industrial machines for tension monitoring.

Advantages

- Highest requirements on economic and secure processes
- Innovative digital Hall sensor technology
- Electronics protected from environment
- Designed for highest reliability
- Optimal long-term drift, temperature drift and accuracy
- Tension overload protection
- Protected against electrostatic discharge and machine vibrations
- Improved against abrasion
- Resistance to common spin finishes
- Simple installation and implementation (little space required, easy integration into threadpath)
- Compatible with existing units
- Application in texturing and other industrial machines for tension surveillance

Components in production process of synthetic filaments Yarn tension sensors

Standard Dimensions

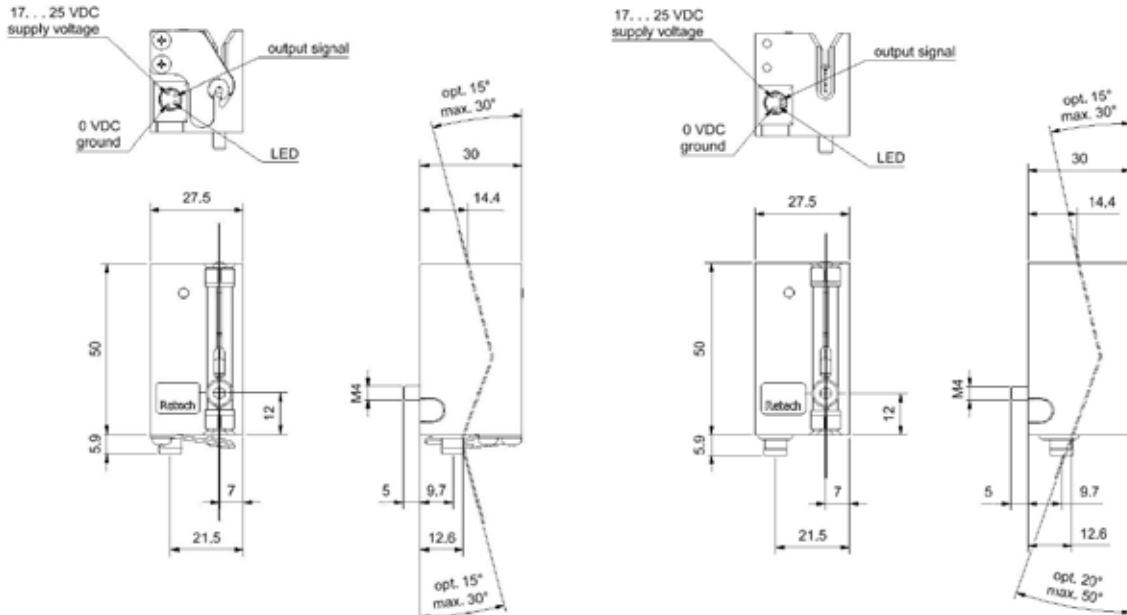

Brief Technical Specification

Supply voltage	17 ... 25 VDC stabilised
Output	0.5 ... 10 VDC
Current	≤ 15 mA
Accuracy	≤ ± 1.25 %
Zero drift	≤ - 0.5 ... + 1.5 % per year
Temperature range	+ 10 ... + 60 °C
Temperature drift	≤ 0 ... + 0.3 % per 10 °C
Humidity	max. 90 % RH at 20 °C
Mechanical resonance	0/60 cN: 90 Hz 0/120 cN: 115 Hz

Measuring Range

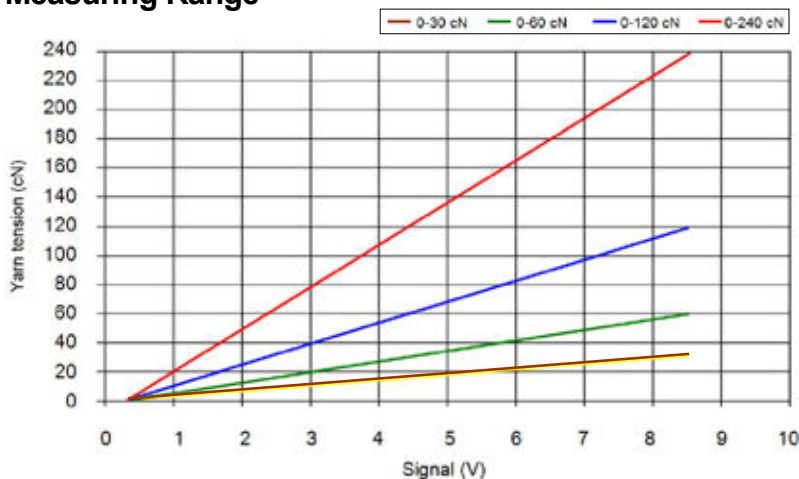

Available Ranges:

0-30 cN, 0-60 cN, 0-120 cN, 0-240 cN

All rights reserved. Subject to change.



Win-OLT

On-line monitoring in production process of synthetic filaments Win-OLT – on-line monitoring of yarn tension

Quality control in texturing means “On-line Tensor” Win-OLT.
The industry standard for high yarn quality and optimised production.

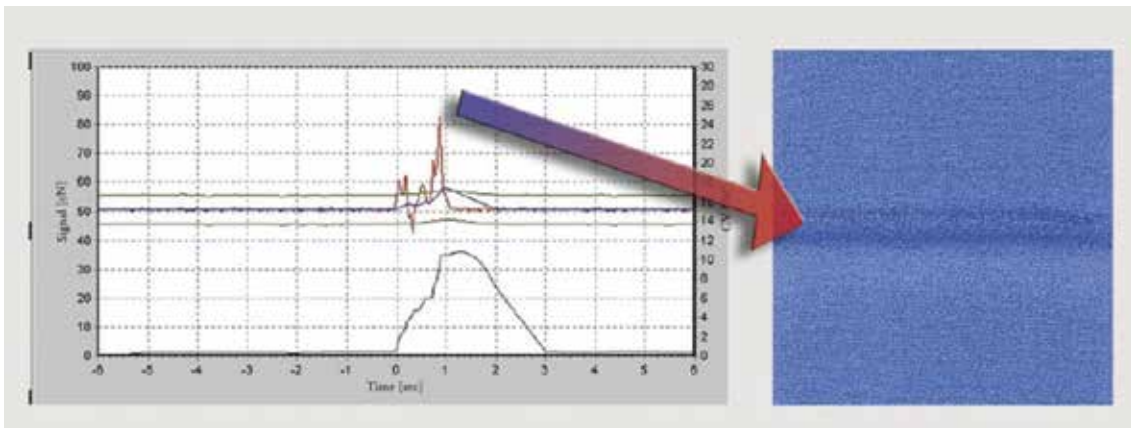

The most important quality parameter in texturing is the correct yarn tension. Abnormal tension levels and peaks result in dyeing problems.

The increased quality demanded for textured yarns, the use of new materials and of microfilaments, together with an increase in texturing speeds, require quality controls that are more and more extensive. The quality control procedures, which are sometimes very labor intensive, can be substantially reduced by using on-line process monitoring, e.g. by measuring yarn tension continuously.

In the case of Win-OLT, RETECH has developed a yarn tension measuring system that continuously monitors yarn tension, records yarn breaks, calculates downtimes and provides machine efficiency and quality data.

Substantial advantages are

- Waste reduction due to early detection
- 100 % quality control during production
- Cost effective quality assurance
- Documented production process
- Short pay back periods
- Latest hardware and software
- Multi-tasking, easy connection to networks for tele-service and control by internet or intranet
- Wide range of facilities for fault detection by application of user defined parameters
- User-friendly computation by means of graphic data
- Language options – including Chinese and Korean
- Analysis of production data by the program
- Recording of yarn tension at all positions enabling long term analysis
- Optical indication of package quality by means of LED sensors
- Integral doff timer
- Optimized label printing options
- Simple connection to existing yarn cutting systems
- Extendible software architecture for future additions, e.g. for measuring package density (PD).

The Win-OLT system guarantees

- Continuous tension monitoring
- Recording of yarn faults
- Quality classification by number of faults
- Display of events for error analysis
- Optical “quality-alarms”
- Detection of surge speed
- Faults are recognised immediately

- Detection of faults that infrequently occur
- Indications on type and source of fault by graphic presentation
- Optimisation of spinning process

The Win-OLT system consists of a sensor, microprocessor and a computer system, together with the appropriate software. The sensors and system are available for all types of texturing units.

However texturing is not the only use for this system. It is also suitable for monitoring the yarn tension in other textile processes. Examples of this are spinning, winding, covering and draw twisting, among others.

Win-OLT Hardware

The Win-OLT hardware features an open system structure for simple and customer-friendly integration into new or existing texturing machines. The components comprise modern, high performance electronics, which ensure rapid processing of data.

Advantages

- Modular system structure enabling installation on all texturing machines and twist units
- Simple connection to machine interfaces and/or other systems due to standard interface (CAN bus)
- Additional cards, which enable a simple and economical interface with existing yarn cutters on the machines
- Instantaneous information concerning current package quality from the LED located on the yarn tension sensor ZKS51
- Optical signals, located both on cabinet and sensor, indicating the time of doffing
- Possibility to doff individual positions via the "Manual Random Doffing Box" for achieving equal package running times (even for older machines). This is an ever-increasing requirement in many downstream processes for textured PA and PES
- Possibility of using label printers to print labels for documenting the package quality
- Possibility to connect up to 480 sensors to the system
- User-friendly software maintenance through FLASH EPROM

Yarn tension sensor ZKS

The measurement principle is based on the HALL effect. Here, through the measurement of magnetic field intensity, a signal that is proportional to yarn tension is converted into a voltage. Continuous measuring accuracy over many years is ensured through the above measuring principle and the compact and stable structural design of the sensor.

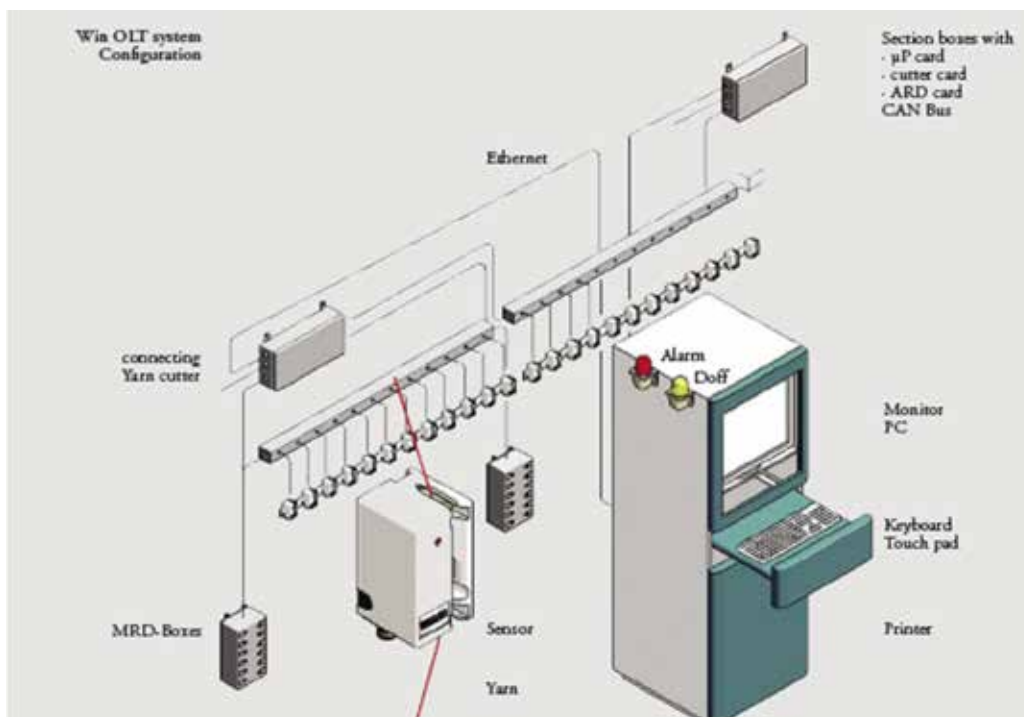

Win-OLT Software

Advantages

- WINDOWS XP operating system
- Modular structure and easier fulfilment of customer wishes
- Self-evident graphic and tabular displays
- Input masks for simple handling
- Multiple error recognition tolerance limits for individual quality requirements
- Freely selectable fault occurrence numbers for defining A, B or C quality
- Storing of individual tension trace faults for cause analyses
- Quality displays via tables, signal lamps and sensor LED, yarn cutting possibilities
- Production display according to yarn length, weight and run duration
- Tables showing the actual statistical values of each position
- Password protection for 1 user, extendable to 10 users
- Pre-set for LAN
- Multiple analysis of the entire production by the Win-OLT statistics program

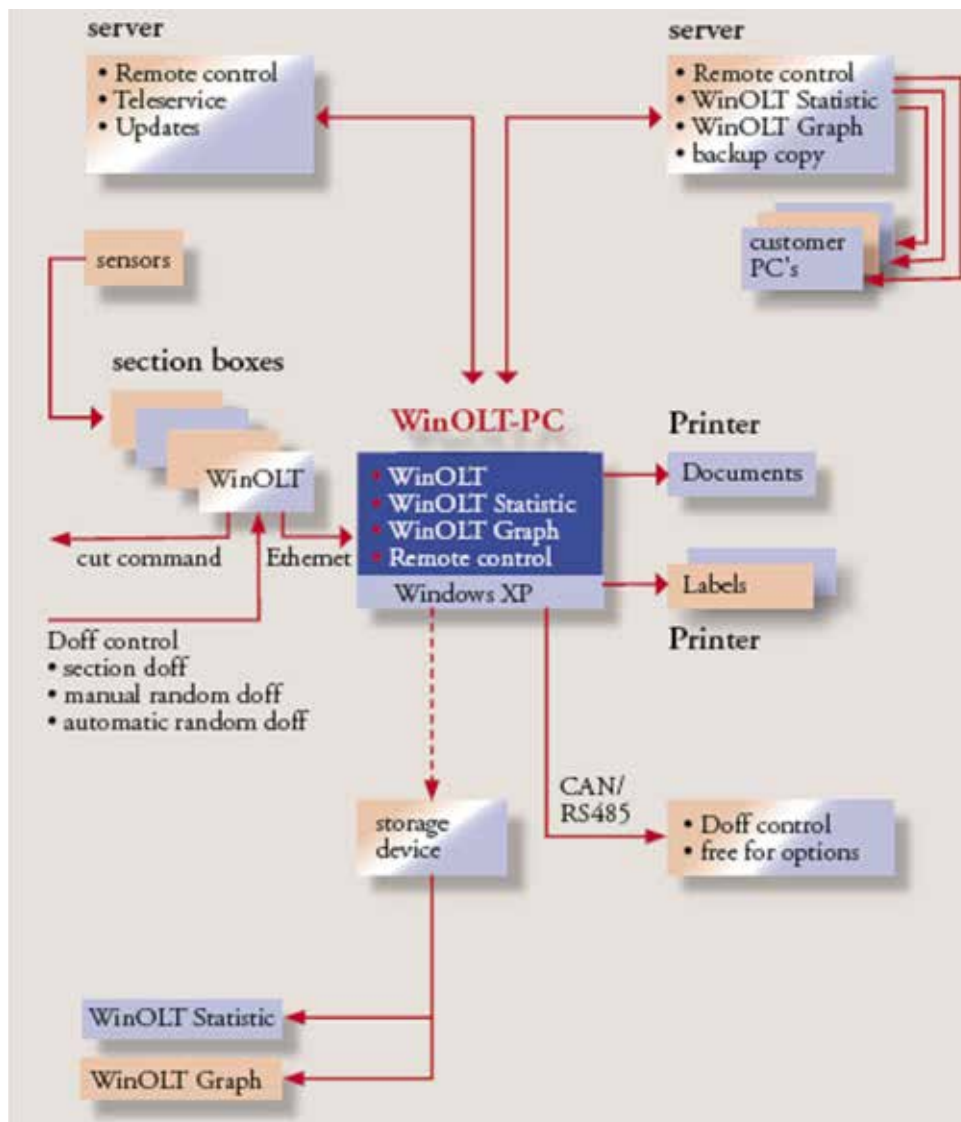

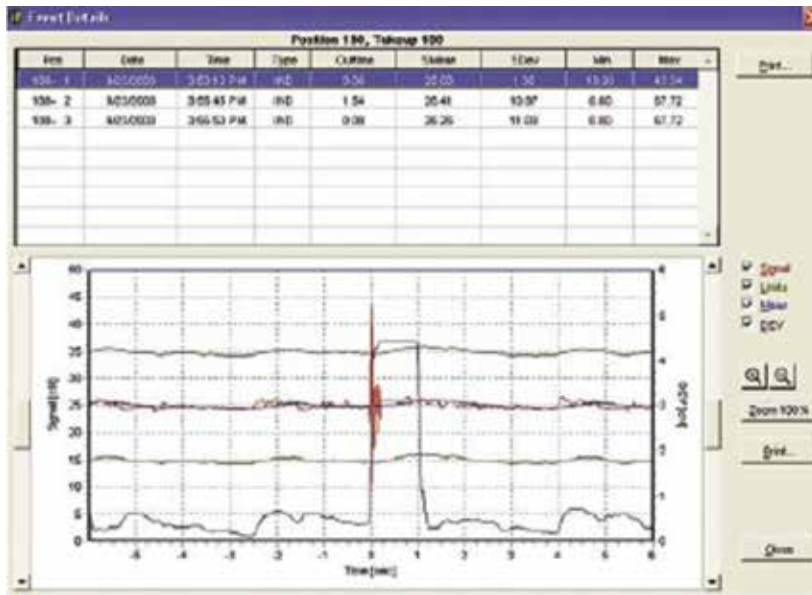

Working mode

After the input of all process parameters and the start of production, Win-OLT monitors the yarn tension at every position 50 times per second.

If the number of pre-defined faults is exceeded, it will be clearly recorded in the table and indicated both by the sensor LED and a bright alarm indicator located on top of the cabinet.

If a machine has been fitted with a quality level yarn cutting device, Win-OLT will then, when requested, cut the yarn for these instances.

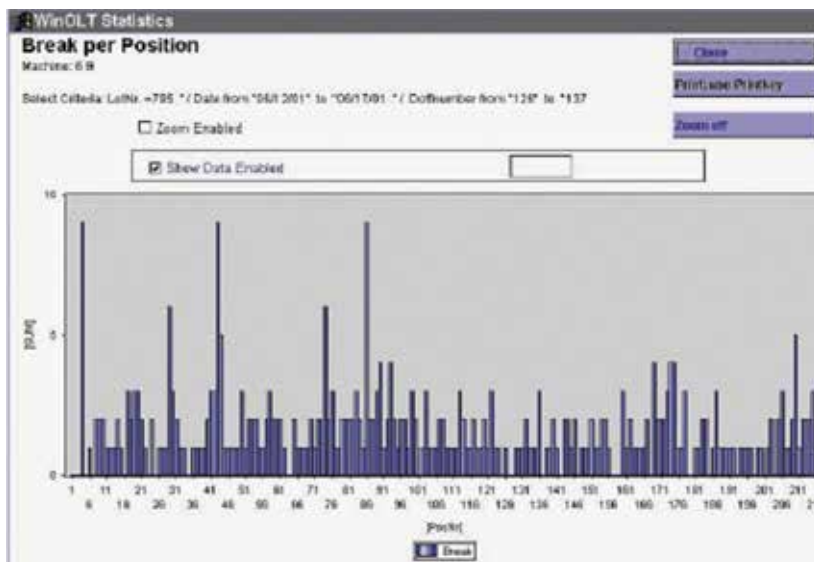

Control working mode and analysis

During production many problems can accumulate, which are not easily recognised. Without process tension control, these faults are usually only detected later in the fabric.

The Win-OLT software offers many options for obtaining a clear overview of production and quality situations at any time. If there are unknown problems with machine positions, Win-OLT offers a graphical option to find the origin of the fault.



Drawing Machines Plant Engineering

Customized draw frames in production process of
synthetic filaments



Retech customized draw frame for spin draw applications acc. customer's request

Vario-Max – Pilot Drawing Machines

Retech proposes customized solutions, individual design as per customer's specific requirement, multi functional and extremely flexible concepts and superior quality manufacturing. Lab line and production scale, ranging from scientific application to manufacturing.

Plant Engineering

“From concept to finished draw stand” for yarn producers, R&D institutes and engineering companies.

Retech are specialists in the development of innovative, efficient and high quality plant engineering. Having been in the business of supplying thermal and mechanical process equipment for synthetic fibres for more than 35 years, Retech has accumulated a tremendous amount of know how in plant engineering as well as in the engineering of machines for state of the art processes. Retech is providing problem solving knowledge for decision making professionals responsible for design, engineering, installation, operation and maintenance facilities, equipment and systems in the field of synthetic fibres.

Customized draw frames in production process of synthetic filaments



Characteristics

- Modular design: draw off unit, draw unit, take off unit
- Layout of the draw stand according to customer's specification
- Flexible arrangement of the rolls
- Optional integrated devices / equipment, e.g.: suction / cutting, spin finish applicator, entanglement, BCF texturizing jet, cooling drum, threadline sensor
- Mechanical design incl. machine frame, electrical layout and cabinet, definition of the interface and operator software
- Building the complete draw stand including acceptance trials
- The responsibility for the process remains with the customer

Advantages

- Maximum variation of machine set up, modular design allows fast alteration
- Machine alignment according to customer's individual requirement
- Pull in, pull out concept which covers a large variety of process parameters, e.g.: POY, HOY, FDY, BCF
- Compact design, very user friendly handling
- Energy Saving Motors, ESM for the godet rolls
- Various high grade godet roll coatings available, according to customer's process parameters
- High and low speed versions available, e.g.: min. 1 m/min. / max. 6500 m/min.
- High temperature options 300°C
- Multi zone heating achieving accuracy $\pm 1.0^\circ\text{C}$
- LCR Liquid Cooled Roll option
- Options for additional devices on the yarn path

Re-designing, modification, conversion, revamping and upgrading are also vital topics such as:

- Replacement of temperature transmitters in existing godet rolls
- Conversion of existing draw units using new generation godet rolls
- Overhauling and repair of existing godet rolls
- Implementation of Win-OLT yarn tension monitoring system on existing DTY machines
- Exchange existing air bearing separator rolls with up to 30 % air pressure savings



TEX2000

Machines in production process of synthetic filaments TEX2000-L – DTY laboratory and pilot machine



Processes

- False-twist draw texturing

Machine Types

- Pilot machine, 1 position
- Production machine, up to 48 positions

Characteristics

- Modular design with 1 to 48 positions
- Modules can be added with ease and at any time
- Texturing of diverse polymers (PET, PA, PP, PLA, bicomponent yarns, specialities)

Advantages

Production:

- High level of flexibility, small quantities exactly on demand
- Comfortable handling, string-up from the floor, short yarn path, 100% surveyable
- Practically no wear and tear parts, minimum idle times due to short cleaning time
- Positions can be set individually with numberless options in settings and parameters

Technology:

- Wide process window due to simultan or process and heated draw process
- Very high speed, depending on process
- Draw rolls render high temperature range (60 to 250 °C). This allows a production of diverse materials without any changes
- Titre range from fine with a large number of filaments to more course count yarns
- Options available, according to customer request

Machines in production process of synthetic filaments TEX2000-L – DTY laboratory and pilot machine

Standard Dimensions

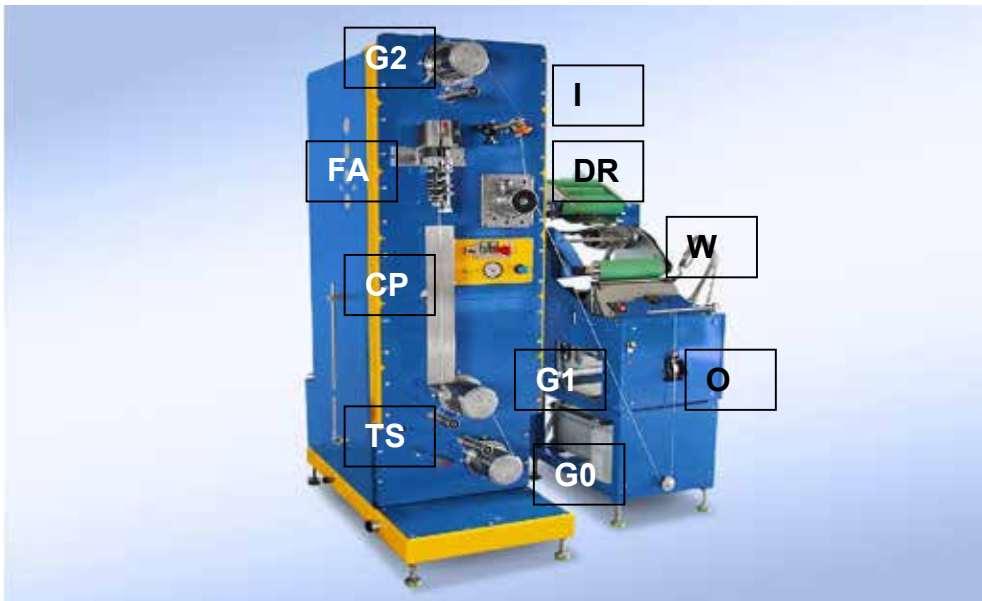

Brief Technical Specification

- yarn and process data

- yarn data	[PET, PA, PP, PLA]			
titre range		[max den]	(20) 50 to 400 (600)	(depending on process conditions)
- process data				
temperature		[max °C]	: 60 to 250°C	
speed, mech.		[max m/min]	: up to 1800	(depending on process conditions)

- machine data

(components of unit as illustrated)

- Bobbin creel	[mm]	: 1400 x 650 x 600	(h / w / d)
- Production unit	[mm]	: 2050 x 600 x 1200	(h / w / d)
G0 delivery godet	[mm]	: ø 127 x 150, heated	
G1 draw godet	[mm]	: ø 127 x 150, heated	
TS twist stopper			
CP cooling plate			
FA friction aggregate		: Temco FTS 525	
on-line tension control		: Win-OLT	(optional)
G2 delivery and setting godet		: ø 127 x 150, cold	(heating optional)
I intermingling		: Heberlein Slide-Jet	(optional)
DR delivery roll	[mm]	: ø 80 x 100, cold	
- Winding unit	[mm]	: 1650 x 500 x 1050	(h / w / d)
O oiling		: Oil roll applicator	(optional)
W winder		: SSM Digicon – Preciflex, with auto doffing	
bobbins format, weight		: 290 x min. 56 x 3.5 mm, up to 6000 g	

All rights reserved. Subject to change.



Retech Aktiengesellschaft
Lindenmattstrasse 16
CH-5616 Meisterschwanden
Switzerland

Phone: +41 56 676 66 33
Fax: +41 56 676 66 36
E-mail: info@retech.ch

www.retech.ch